

HVAC Control System

Christian Casseus, Nicolas Helffrich, Thomas Renzo, and Jon Saul

Dept. of Electrical Engineering and Computer Science, University of Central Florida, Orlando, Florida, 32816-2450 (12 point Times font)

Abstract — Development of a residential smart heating, ventilation, and air conditioning system (HVAC). This paper describes the development team's approach to integrate multiple temperature and relative humidity sensors. In addition, CO₂ measurement are observed. Sensor data is then used to intelligently manage a residential HVAC to maximize power efficiency, maximum comfort, or a combination of both. The Industrial, scientific and medical (ISM) radio band is utilized to provide communication between remote sensors and main control unit.

Index Terms — Temperature control, heating, cooling, remote sensing, energy efficiency

I. INTRODUCTION

Buildings now represent the largest use of energy, with the air conditioning consuming approximately 50% of that #1 energy usage. As a result of this cost and environmental impact, government goals are to force cutbacks on use of air conditioning -- unless a practical way is found to reduce energy use and cost.

In today's age many system are required to communicate with other systems via a RF technology. Our team wanted to research modern day RF technologies and integrated one or more of the technologies into the design. Following research discusses the common available RF communication technologies and determines which technologies would be appropriate for the project.

The ability to place an instrument virtually anywhere has tremendous benefits. In the past most remote sensing was accomplished by connecting the remote sensors or instrumentation directly with physical medium e.g. cabling and fiber. For many applications, using a physical medium to provide connectivity is impracticable, cost prohibitive, or both. In the last decade, many technologies have advanced to a point that low-cost, low-power wireless communication between devices a practicable solution. This team would like to advance our knowledge about and include low-cost and low-power wireless solution in this project.

II. Overview

The goal of this project was to design and build a HVAC control system to provide significant energy savings and increased comfort to a typical residential user which can easily integrate into most commonly install home HVAC system; little to no addition structural wiring; In addition, this team will evaluate previous projects for best design options

Driver to the design were from reviewing the design and parts selections of the prior groups, for the best approaches keeping in mind costs, reliability, and flexibility for future upgrades, of a Production Unit. In addition, individual team member interests are taken into account. Mandatory requirements were developed and listed below.

1. Mandatory Requirements:
2. Measure indoor and outdoor temperatures and relative humidity.
3. Measure indoor temperature (+- 0.5 °C) and relative humidity (+- 5%) with specific accuracy.
4. Measure outdoor temperature (+- 1 °C) and relative humidity (+- 10%) with Production ready prototype.
5. Review previous design projects for the design and parts selections for the best package of costs, reliability, and flexibility for future upgrades.
6. Wireless transmit of remotely located sensor data
7. LCD Touch screen interface

The HVAC system is able to sense temperature and humidity inside and outside of the residence and CO₂ levels inside the building. Optional features such as mood scents, dampers, and air filter quality alarm are desired and will be integrated into the design, time permitting. The interface required to be advanced but user friendly and have quick response to the touch. The system makes decisions makes changes to the status of the HVAC with user interface although user will be able to manually override the control if needed.

This HVAC system is a smart air conditioning system that will utilize sensors and automated air vents to minimize electricity cost and maximize energy use. The system will be controlled from a central station. The user will need to do nothing more than specify the settings desired. From there the system will manage the ventilation system of the house to meet the specified settings. The HVAC system will not simply blow cold air or hot air base upon the user's input but it will utilize the outside air as well to be used for a more efficient air flow system. The HVAC will be utilizing a variety of sensors to retrieve readings from inside and outside of the building. With this the system will be able to adjust the temperature settings for inside the building by making use of the air flow from

outside. This would require an exterior sensor which would be powered by an outside source. The sensor will be sending readings wirelessly using radio frequency, RF. This sensor measure temperature and humidity and with these readings the HVAC system will know whether it will be more efficient to use air from outside to meet the settings instead of wasting power in doing all the work internally.

For safety reasons, a CO2 sensor was added to previous revision of the HVAC system. The purpose of the CO2 sensor was to measure CO2 readings of the building or particular rooms. This is made useful because not only does it bring about a more environmentally safe building I t will also keep those with in the building out of harm's way from CO2 related injuries. This sensor's reading would be used by the main system and if the readings were too high the ventilation system would be controlled in a manner to attempt to safely discard the CO2 threat. The system also has the capability of sounding an alarm when CO2 readings reached a dangers level.

Most residential heating and air conditioning is controlled by a centrally install thermostat. Almost all residential thermostats control the separate heating and air conditioning element the same by sending on and off control signals to each component in HVAC. When heat is required, the thermostat initiates or sends a control signal to a heating subsystem. Air conditioning is controlled the same way. The most common method is the thermostat will send a control signal that activates or deactivates a power relay or to a separate control board in the air conditioning or heating systems.

Basic residential thermostats control three subsystems of a HVAC: Heating, cooling, and fan. Advanced or programmable thermostat adds logic circuitry to add addition functionality for the user but still only control the three subsystems.

Typically HVAC control signals consist of turning on and off 24 VAC to the three subsystems. Typical residential control circuit is below in Figure 1.

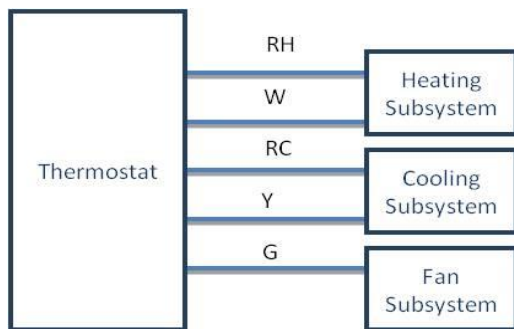

Figure 1: Typical Residential Thermostat Wiring

III. DESIGN OVERVIEW

The basic block diagram for the project is displayed in Figure 2. There are three main block to this project: remote temperature and relative humidity sensor with applicable RF communication main control unit, main control unit with applicable RF communication with remote unit, and user interface. In the following sections each block is discussed in detail

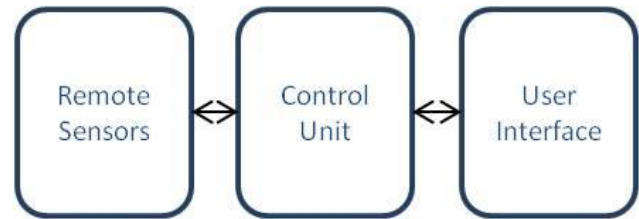

Figure 2: High Level Diagram

A. Remote Sensors

The main components of the remote unit are the temperature, relative humidity, microprocessor and RF transceiver. The team researched competing technologies for each of the sensing capabilities and completed comparisons to include: ease of integration, cost, and accuracy. Decisions on which technologies to utilize with this project were then based on these comparisons. When the user changes the temperature on the thermostat our system will respond by checking to see what the current interior and exterior temperature and relative humidity are, compare them with what the user input was, and then make the proper decision autonomously to cool, heat, dehumidify or put natural air into the house or building. We want to have a high degree of accuracy here to have the highest responsiveness to the users input and decisions. Figure 3 displays the block diagram for the remote unit.

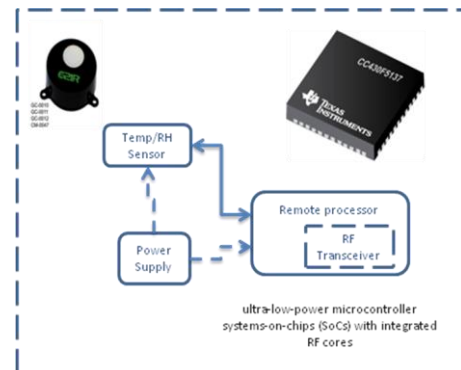

Figure 3: High level Remote Sensor Diagram

The remote unit will receive a signal from the main control unit telling it to take a sample from the SHT71 sensor, it will then process that information and send it back to the main control unit. After the information is sent then the unit will return back to the low power mode so that battery life is conserved. The reason for the remote unit is to not only monitor the outdoor temperature and humidity conditions so the user can tell what is going on just from looking at their thermostat, but also to make smart decisions and to control some of the exterior devices being controlled. For example the natural air system is more energy cautious than the AC system so if it is 65 degrees outside the HVAC system will make the smart decision to use the natural air to cool the house instead of the AC. If conditions are hot and humid outside the remote unit wont trigger anything but continuously update the system about the conditions outside the building.

For the temperature sensors the team researched Resistive Temperature Devices (RTD) and thermistors. Well performing thermistors can be found at a reasonable price.

A RH sensor goes hand in hand with the temperature sensor, sometimes the temperature isn't too high but it may feel hot in the room because it is humid, especially in states like Florida. The RH sensor will be acting synchronously with the temperature sensor to determine the best way to cool the unit. If it is humid inside and not outside the outdoor RH sensor will be able to determine that and from there make the smart decision to possibly pump natural air into the building from outside.

Our team selected two sensors to utilize. Our team selected the Sensirion SHT71 because of the package. Leads on the SHT71 allow easier integration and mounting as compared to a DFN package on the SHT21. Figures 5 and 6 display the tolerance of the temperature and relative humidity, respectively. On board analog to digital conversion minimizes errors due to analog degradation during transmission to a analog to digital converter. The SHT21 and SHT71 tolerances meet or exceed our requirements. The temperature tolerance indicates error of greater than 1 C below -20C and above 90C. Our intended temperature range for this project spans between 0C and 40C. Other reasons for selecting the SHT71 include the ability to maximize our power usage for the remote modules, the sensor come calibrated from the factory, and the sensor is constructed for use in wet environments.



Figure 4. Sensirion SHT 71. Reprinted with Sensirion permission

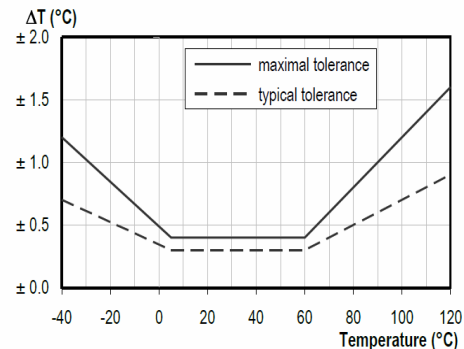

Figure 5: Sensirion SHT 71 temperature responses. Reprinted with Sensirion permission

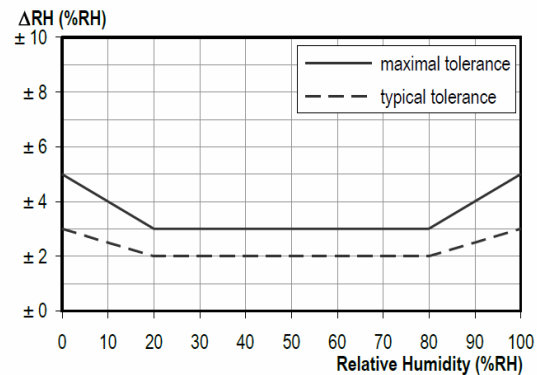

Figure 6: Sensirion SHT 71 relative humidity responses. Reprinted with Sensirion permission

The second sensor, COZIR Ambient, 2000 ppm CO2 sensor, with integrated temperature and relative humidity, was also chosen to evaluate. The COZIR GC-0020 is an ultra-low powered sensor which consumes 3.5 mW of power, runs on 3.3V and has a peak current draw of 33mA with an average current less than 1.5mA. Utilizing the integrated temperature and relative humidity sensor, power consumption will slightly increase. The sensor outputs an analog and digital signal.



Figure 7. COZIR. Reprinted with CO2Meter, permission

The team had numerous difficulties when integrating the Sensirion SHT71. The team discovered the communication of the SHT71 utilized a two wire, digital, serial data stream for connection to a microcontroller. Although similar to the I2C standard, the serial bus did not follow the I2C standards. The team was never able to establish communication with the microcontroller. Due to time constraints, the team decided to utilize the COZIR sensor for both the remote sensors and the inside control unit.

Numerous microcontroller and RF transceivers were researched. The team chose Texas Instrument's CC430 line of microcontrollers with integrated transceivers due to the cost and the availability of developmental kits. The team decided to utilize the CC430F5137. The team estimated the cost to utilize CC430 and associate antenna at ~\$20 compared to previous teams using an MSP430 microcontroller and Xbee shield at ~\$42. Further discussion of the CC430F5137 in section B, *USER MAIN CONTROL UNIT*

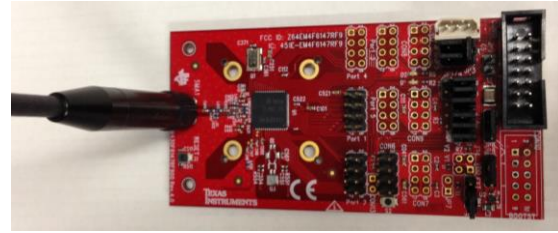

Figure 8: CC430 developmental board. Reprinted with Texas Instruments permission

B. USER MAIN CONTROL UNIT

Figure 9 displays the block diagram of the main control unit. These subsections accomplish two functions, 1) receives data from the local and remote sensor and transmit the data to the user interface, and 2) receives control signals from the user interface and enable/disable relays.

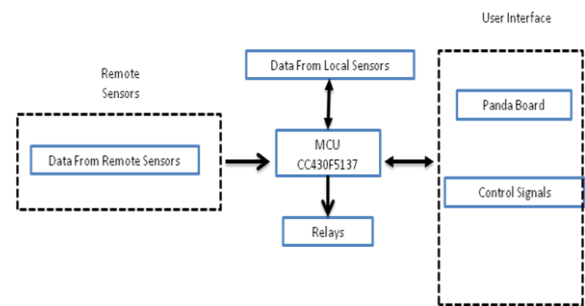

Figure 9: Block diagram of the main control unit

Frequency (MHz)	20
Flash (KB)	32
SRAM (B)	4096
GPIO	30
Timers – 16-bit	2
ADC	Yes
ADC Channels	6
Other Integrated Peripherals	32-bit HW Multi, A/Sync Serial Comm USCI, AES-128 En/Decrypt, CRC16, DMA, RTC, Sub 1GHz RF Transceiver , Universal Clock

Table 1: CC430F5137 specifications

Our team began research into different method of communication between the remote sensors and the main microprocessor. To aid in future installations, the sponsor prefers wireless over direct wired communications as installation time could be reduced if an installation of a wired infrastructure is not required. The teams planned to utilize the unlicensed industrial, scientific and medical (ISM) radio and SRD (Short Range Device) bands to support wireless communication. Table 2 displays the current list of authorized frequency bands which may be useful for this project. These bands are typically support by electronics industry via integrated components. The team's research into low cost and low power devices supporting these unlicensed frequencies have limited these frequencies to the bands listed in Table 2. These bands have strict guidelines for use with the main restriction limits the maximum allowable transmit power.

Our team researched multiple options of transferring data between the remote and main units. Previous design

teams have opted to utilize an 802.15 protocol, via the XBee. Our team also believes the remote communication method should take into account a low power solution to optimize installation locations. Other methods our team has compared include 2.4 GHz RF communication solutions and sub 1 GHz RF communication solutions. Considering transmitted powers are the same, higher frequencies experience higher propagation losses than lower frequencies due to reflection and bending of radio frequencies as the propagate through materials. Real-world propagation estimates indicate devices using 915 MHz have a propagation distance 2-3 longer than devices using 2.4 GHz [1].

Frequency range		Band
164 MHz	192 MHz	SRD
433.050 MHz	434.790 MHz	SRD and ISM
863 MHz	870 MHz	SRD
902.0 MHz	928.0 MHz	ISM
2400.0 MHz	2483.5 MHz	SRD and ISM
5725 MHz	5875 MHz	SRD
24.00 GHz	24.25 GHz	SRD
61.0 GHz	61.5 GHz	SRD

Table 2: Possible unlicensed ISM and SRD frequencies

The MCU enables relays which in turn completes a 24 VAC circuit to HVAC components. The MCU enables relays by receiving the controls from the user interface and outputting ~3VDC on the appropriate CC430 port/pin. This voltage is applied to the base of the transistor in the relay circuit, see Figure 10, which supply the necessary current to close the relay contacts. Ten CC430 ports/pins are used to control 10 relays.

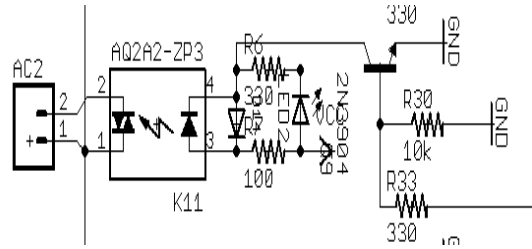

Figure 10: AC relay control circuit

The team decided to utilize solid state as compared to previous project use of electromechanical relays. One of the noticeable concerns what the level of noise previous relay made when the contact were opened of closed. Even at a distance of feet away from the relays, the contact closing noise was extremely audible and easily startles and unsuspecting person. The team chose the Crydom CX240D5R (Figure 11) solid state relay. This relay allow between 3-15 VDC for control voltages and a load current up to 5 A. The reason for the relays being on the main unit is because all the control signals for the AC, dehumidifier, heater, fan, etc. are located where the 24VAC is. Crydoms CX240D5R solid state relays were chosen. These were picked with electrical noise and longevity in mind. The previous HVAC groups used electromechanical relays which were loud and wouldn't be pleasant for the user to hear, although the price point on the SSR's were a few dollars higher ~\$11 for one relay the amount of time they last will eventually pay for themselves.



Figure 11: Crydom Relay

The relays are powered with 5VDC and triggered from a high (ON) signal from the microprocessor which will trigger the NPN transistor and allow current to flow through to ground turning the relay ON. When the microprocessor sends out a low signal the relay will remain off. We will have a relay board built for use with up to 10 relays although we won't be testing as many they are there encase the sponsor decides to implement any future features to the HVAC system.

The main control unit also utilizes the Texas Instruments CC430F5137 to provide RF communication between the main control unit and remote sensors, see Figure 8. As the CC430 receives both local and remote sensor data, the CC430 retransmits the sensor data serially to the user interface. The CC430 also receives control signals from the user interface via the same serial connection. The CC430 uses these control signals to output a voltages or grounds via the appropriate CC430 port/pin. Due to uncertainty with which CC430 port/pins would be required, we opted to bring all input/output pin out to header. This will enable last minute changes for sensor connection, if needed. Figure 12 displays the current pin configuration of the CC430F3137.

CC430 Pin	Header Pin
P2.0/PH_1/TA0CC0M/CE0/A0	1/PH
P2.1/PH_2/TA0CC0M/CE0/A1	2/PH
P2.2/PH_3/TA0CC0M/CE0/A2	3/PH
P2.3/PH_4/TA0CC0M/CE0/A3	4/PH
P2.4/PH_5/TA0CC0M/CE0/A4	5/PH
P2.5/PH_6/TA0CC0M/CE0/A5	6/PH
P2.6/PH_7/TA0CC0M/CE0/A6	7/PH
P2.7/PH_8/TA0CC0M/CE0/A7	8/PH
P2.8/PH_9/TA0CC0M/CE0/A8	9/PH
P2.9/PH_10/TA0CC0M/CE0/A9	10/PH
P2.10/PH_11/TA0CC0M/CE0/A10	11/PH
P2.11/PH_12/TA0CC0M/CE0/A11	12/PH
P2.12/PH_13/TA0CC0M/CE0/A12	13/PH
P2.13/PH_14/TA0CC0M/CE0/A13	14/PH
P2.14/PH_15/TA0CC0M/CE0/A14	15/PH
P2.15/PH_16/TA0CC0M/CE0/A15	16/PH
P2.16/PH_17/TA0CC0M/CE0/A16	17/PH
P2.17/PH_18/TA0CC0M/CE0/A17	18/PH
P2.18/PH_19/TA0CC0M/CE0/A18	19/PH
P2.19/PH_20/TA0CC0M/CE0/A19	20/PH
P2.20/PH_21/TA0CC0M/CE0/A20	21/PH
P2.21/PH_22/TA0CC0M/CE0/A21	22/PH
P2.22/PH_23/TA0CC0M/CE0/A22	23/PH
P2.23/PH_24/TA0CC0M/CE0/A23	24/PH
P2.24/PH_25/TA0CC0M/CE0/A24	25/PH
P2.25/PH_26/TA0CC0M/CE0/A25	26/PH
P2.26/PH_27/TA0CC0M/CE0/A26	27/PH
P2.27/PH_28/TA0CC0M/CE0/A27	28/PH
P2.28/PH_29/TA0CC0M/CE0/A28	29/PH
P2.29/PH_30/TA0CC0M/CE0/A29	30/PH
P2.30/PH_31/TA0CC0M/CE0/A30	31/PH
P2.31/PH_32/TA0CC0M/CE0/A31	32/PH
P2.32/PH_33/TA0CC0M/CE0/A32	33/PH
P2.33/PH_34/TA0CC0M/CE0/A33	34/PH
P2.34/PH_35/TA0CC0M/CE0/A34	35/PH
P2.35/PH_36/TA0CC0M/CE0/A35	36/PH
P2.36/PH_37/TA0CC0M/CE0/A36	37/PH
P2.37/PH_38/TA0CC0M/CE0/A37	38/PH
P2.38/PH_39/TA0CC0M/CE0/A38	39/PH
P2.39/PH_40/TA0CC0M/CE0/A39	40/PH
P2.40/PH_41/TA0CC0M/CE0/A40	41/PH
P2.41/PH_42/TA0CC0M/CE0/A41	42/PH
P2.42/PH_43/TA0CC0M/CE0/A42	43/PH
P2.43/PH_44/TA0CC0M/CE0/A43	44/PH
P2.44/PH_45/TA0CC0M/CE0/A44	45/PH
P2.45/PH_46/TA0CC0M/CE0/A45	46/PH
P2.46/PH_47/TA0CC0M/CE0/A46	47/PH
P2.47/PH_48/TA0CC0M/CE0/A47	48/PH
P2.48/PH_49/TA0CC0M/CE0/A48	49/PH
P2.49/PH_50/TA0CC0M/CE0/A49	50/PH
P2.50/PH_51/TA0CC0M/CE0/A50	51/PH
P2.51/PH_52/TA0CC0M/CE0/A51	52/PH
P2.52/PH_53/TA0CC0M/CE0/A52	53/PH
P2.53/PH_54/TA0CC0M/CE0/A53	54/PH
P2.54/PH_55/TA0CC0M/CE0/A54	55/PH
P2.55/PH_56/TA0CC0M/CE0/A55	56/PH
P2.56/PH_57/TA0CC0M/CE0/A56	57/PH
P2.57/PH_58/TA0CC0M/CE0/A57	58/PH
P2.58/PH_59/TA0CC0M/CE0/A58	59/PH
P2.59/PH_60/TA0CC0M/CE0/A59	60/PH
P2.60/PH_61/TA0CC0M/CE0/A60	61/PH
P2.61/PH_62/TA0CC0M/CE0/A61	62/PH
P2.62/PH_63/TA0CC0M/CE0/A62	63/PH
P2.63/PH_64/TA0CC0M/CE0/A63	64/PH
P2.64/PH_65/TA0CC0M/CE0/A64	65/PH
P2.65/PH_66/TA0CC0M/CE0/A65	66/PH
P2.66/PH_67/TA0CC0M/CE0/A66	67/PH
P2.67/PH_68/TA0CC0M/CE0/A67	68/PH
P2.68/PH_69/TA0CC0M/CE0/A68	69/PH
P2.69/PH_70/TA0CC0M/CE0/A69	70/PH
P2.70/PH_71/TA0CC0M/CE0/A70	71/PH
P2.71/PH_72/TA0CC0M/CE0/A71	72/PH
P2.72/PH_73/TA0CC0M/CE0/A72	73/PH
P2.73/PH_74/TA0CC0M/CE0/A73	74/PH
P2.74/PH_75/TA0CC0M/CE0/A74	75/PH
P2.75/PH_76/TA0CC0M/CE0/A75	76/PH
P2.76/PH_77/TA0CC0M/CE0/A76	77/PH
P2.77/PH_78/TA0CC0M/CE0/A77	78/PH
P2.78/PH_79/TA0CC0M/CE0/A78	79/PH
P2.79/PH_80/TA0CC0M/CE0/A79	80/PH
P2.80/PH_81/TA0CC0M/CE0/A80	81/PH
P2.81/PH_82/TA0CC0M/CE0/A81	82/PH
P2.82/PH_83/TA0CC0M/CE0/A82	83/PH
P2.83/PH_84/TA0CC0M/CE0/A83	84/PH
P2.84/PH_85/TA0CC0M/CE0/A84	85/PH
P2.85/PH_86/TA0CC0M/CE0/A85	86/PH
P2.86/PH_87/TA0CC0M/CE0/A86	87/PH
P2.87/PH_88/TA0CC0M/CE0/A87	88/PH
P2.88/PH_89/TA0CC0M/CE0/A88	89/PH
P2.89/PH_90/TA0CC0M/CE0/A89	90/PH
P2.90/PH_91/TA0CC0M/CE0/A90	91/PH
P2.91/PH_92/TA0CC0M/CE0/A91	92/PH
P2.92/PH_93/TA0CC0M/CE0/A92	93/PH
P2.93/PH_94/TA0CC0M/CE0/A93	94/PH
P2.94/PH_95/TA0CC0M/CE0/A94	95/PH
P2.95/PH_96/TA0CC0M/CE0/A95	96/PH
P2.96/PH_97/TA0CC0M/CE0/A96	97/PH
P2.97/PH_98/TA0CC0M/CE0/A97	98/PH
P2.98/PH_99/TA0CC0M/CE0/A98	99/PH
P2.99/PH_100/TA0CC0M/CE0/A99	100/PH

Figure 12: CC430F3137 ports

In order for the micro components to run properly on the MCU we have developed a power supply that fits our design needs. Taking the 24VAC which is used to operate relays to switch on and off AC units, we now rectify the AC to convert it to a 5V and 3.3V DC in order to power the microprocessor, CO2 sensor and LCD touchscreen as well as power the relay control. We chose simple switching regulators to power the MCU because they emit less heat than the LDOs that we were looking at as well as not requiring as many external components as some regulators do.

The local sensors on the main control unit will be monitoring the conditions inside the house such as temperature, RH and CO2 levels as described previously. The sensors will constantly be sending readings to the microprocessor to calculate temperature changes and CO2 levels to see if peripheral devices need to be activated or not.

The local CO2 sensor on the MCU will be used to monitor air quality as well as reporting temperature and RH to the user. CO2 levels in a home are very important for living conditions, if levels get too high that the user will be alerted and the system will trigger the relay to flush the house and filter in natural air. Although CO2 levels generally don't reach extreme levels we needed to take the precaution in order to make sure the home remained safe

encase of a fire or an instance where CO2 levels could spike and harm the living quarters.

C. USER INTERFACE

Figure 13 displays the block diagram of the user interface. This subsection consists of a ARM processor using the pandaboard ES using an ARM processor and a 7" Beadaframe LCD touch screen. The pandaboard utilizes Ubuntu as the operating system and allows utilizing the processor to host the decision making algorithm. In addition, the pandaboard host the LCD touch screen interface.

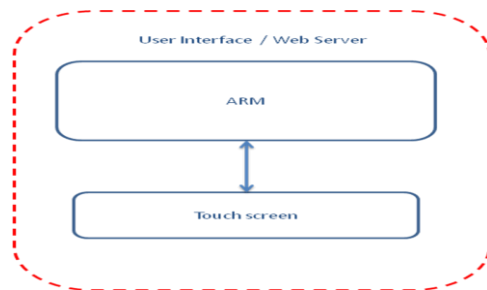

Figure 13: User Interface Block Diagram

Because of the processing capabilities of the ARM, it will be the central to for keeping the whole system running. Alongside, it is where the user will input and see all changes, thus keeping that data in house instead of transferring it elsewhere is the best option. Taking that the day is all store in the ARM it is much efficient to build the decision matrix within the ARM when the user inputs a change in the system. The ARM will monitor and display all of the users input through the use of the LCD screen. Using the LCD screen the user will be allowed to make changes on the system, such as desired temperature and humidity. When changes are made from the user the ARM will then take that change and send it to the decision matrix and determine what should or should not be sent to the Microcontroller. The ARM will send out what actions should be taken based upon the user's new settings. That data will also be replaced with the prior settings of the user. The user will have full control of how the system should be running, such as turning on certain fans and turning them off, tolerance levels, and more. All those settings will be maintained on the ARM and will not be communicated throughout the system for efficiency sake. The only data that will be sent is the result of the decision matrix. The ARM will be sending that data using serial communications. Using commands of two bytes, data will

be sent to the microcontroller so that the system will change accordingly. The result of the decision matrix is nothing more than determining which relay should be on or off. That is the only data the Microcontroller needs to receive from the ARM, though it is capable of more complex operations but, as previously stated, the system was designed this way for efficiency sake. Now the user's data and changes are all kept in one place.

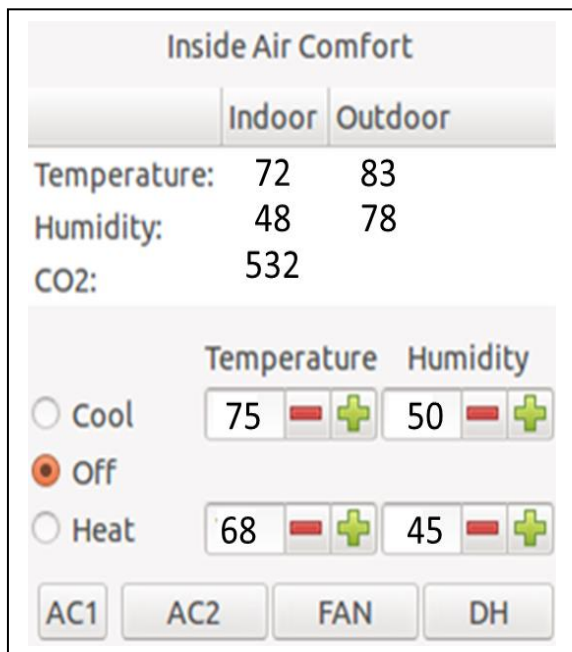

Figure 14: User Interface Screen

The data that the user sees from the Microcontroller is minimal compare to the data the user controls. The only data the user will be able to monitor from the LCD screen will be the current temperature state, humidity state, and CO2 level of the interior of the building and exterior. The CO2 levels for outside the building will not be monitored by the system. Thus in total there are five different states the ARM processor will be receiving from the Microcontroller. Once that data is received it is first compared with the old state of the system to see if there are any changes. This will be done because the system will be receiving new data from the Microcontroller so often it would be inefficient to go through the decision matrix every time new data is received. The Data may be the same as what was previously stored. Once a change has been verified, that data displayed to the user will be updated and the prior will be overwritten. Then that

change will be taken through the decision matrix to determine the proper actions needed. Thus that data will be sent over to the Microcontroller, based upon data received, and the Microcontroller will respond to that action and manage the system as needed.

D. PROJECT POWER

The main control unit will be located inside the house in place of the old thermostat and utilize off the 24VAC on existing wires coming from the HVAC. In order for the micro components to run properly on the MCU, we have developed a power supply that fits our design needs. Utilizing the existing 24 VAC, which is used to operate relays to switch on and off AC units, we rectify the AC to convert it to ~26 VDC and utilize regulators to provide 5V and 3.3V DC in order to power the microprocessor and CO2, temperature, and relative humidity sensor as well as power the relay control. In Figure 15 below, displays the schematic of the main control unit power supplies. We chose simple switching regulators to power the MCU because they emit less heat than the LDOs that we were looking at as well as not requiring as many external components as some regulators do.

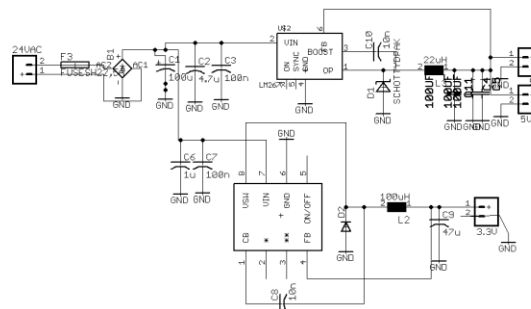

Figure 15: Main Control Unit Power

The remote unit will be powered through AAA batteries producing ~4.5V output, then regulated to 3.3V through a compact high efficient voltage regulator which supplies enough power to the sensor and CC430 which transmits the sensors readings. An image of the schematic for the power can be seen below in Figure 16. Since the remote unit will be active for short bursts of time we wanted to make sure that our device would be highly efficient. The quiescent current is less than 50µA and when the device outputs low power it enters power saving mode.

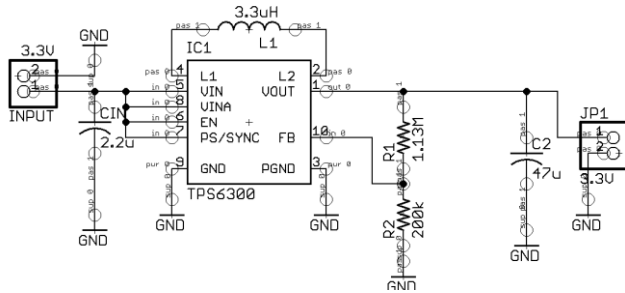

Figure 16: Remote Unit Power

D. SCHEMATICS AND PCBs

The team utilized Easily Applicable Graphical Layout Editor (Eagle) software to accomplish the schematics and printed circuit board (PCB) layouts. Figure 17 illustrates our main controller PCB layout.

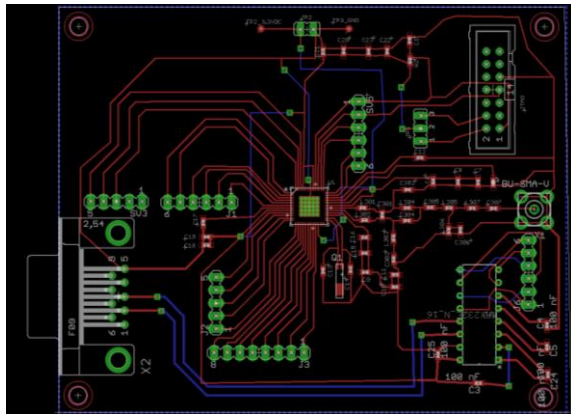

Figure 17: Remote Unit Power

VII. CONCLUSION

This project was well thought out but required many changes throughout design and testing due to parts availability and ability to integrate these parts into the software. Although design and circuit layout were straight forward, a significant effort was required to learn the CC430 software coding, C++ coding for the LCD touch screen and Eagle.

Through senior design I & II we have learned design and how to work as a group and strategize for meetings, presentations and writing technical documents.

It has taught us through our senior design how to analyze a problem and think of many ways to solve it, what to do during setbacks and how to overcome them as a team.

All of the above systems summarize the components that were selectively chosen to make the HVAC project come together and function properly. We hope that through our prototype, the design can be improved and become even better in the future.

THE TEAM



Christian Casseus is a computer engineer. He is 22 years old and has a strong focus on the programing aspect of computer engineer, primarily object oriented programing. Preferred language is Java.

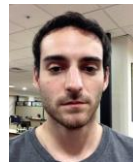

Nicolas Helffrich is a 24 year-old graduating as a Computer Engineer. He hopes to pursue a career as an embedded software engineer. Nicolas' goals are to get a job position which allows for quick elevation.



Thomas Renzo is a 23 year old electrical engineer who hopes to pursue a career specializing in power systems and design. Along with looking into masters program possibilities



Jon Saul is currently a senior at the University of Central Florida. He plans to graduate with his Bachelor's of Science in Electrical Engineering in May of 2013. He currently holds BS in Meteorology from Florida State University and a MS in Meteorology from the Air Force Institute of Technology. He currently works as a senior meteorologist in the space lift industry. He plans on utilizing his BSEE with meteorological and remote sensing instrumentation.

ACKNOWLEDGEMENT

The authors wish to acknowledge the assistance other senior design team for passing on lessons learned while working on their project.

REFERENCES

- [1] Cooper Crouse=Hinds technical document http://www1.crousehinds.com/wirelessio/PDF/White%20Paper/white_paper_frequencies.pdf

